



The Vivari  
Bathroom  
Range

pfeiffer.



# CONTENT

1.	VIVARI® Washbasin	10
2.	VIVARI® VDS R40 and R80 Series	20
3.	VIVARI® TOP Sit-on Basin	26
4.	OPUS Furniture Washstands	32
5.	OLIVE Furniture Washstands	34
6.	BRAVO Furniture Washstands	35
7.	PURE Design Washstand	36
8.	AQUAMASTER Shower Trays	38
9.	AQUAMASTER Baths	44





Experience the integration of a VIVARI® washbasin. The unique look and feel of a solid surface washbasin guarantees many years of satisfaction. Benefit from the easy cleaning and care. Enjoy the feeling of uniqueness.

Every washbasin is handmade. With our wide range of colours, we will meet your design requirements.

Image: VDA 58.370 Integrated washbasin, CUBE bath tub

No day is like any other. Mood, opinions, ideas, everything is constantly changing and this is also true of people's living space. Working together with you, we realise creative room concepts. As a manufacturer and partner, we offer you products and solutions for many areas of use.

We work with different solid surface materials which, in combination with other materials like tiles, wood, concrete, steel or glass allow fascinating forms and surfaces; solid surface materials are robust, non-porous, and easy to maintain.

Image: VDS 470.370.R80 Integrated washbasin





# Design Award

As one of the leading manufacturers in Europe, we produce solid surface products in outstanding quality and design!

Our innovations benefit from our long-term experience in design and manufacturing of furniture components. Numerous awards confirm the quality of PFEIFFER.

Experience prize winning products and innovation strength Made in Germany!



reddot design award  
winner 2008



DESIGNPREIS  
2009  
NOMINIERT



reddot award 2014  
winner



Winner



German  
Design Award  
WINNER 2015



German  
Design Award  
SPECIAL  
MENTION 2015



GERMAN  
DESIGN  
AWARD  
NOMINEE  
2016

## Legend

### Washbasins & Washstands

#### Colour

- ⊗ Limited colours available
- ⊙ All colours available

#### Overflow

- ★ With overflow, incl. overflow set
- Without overflow, waste valve non-lockable

#### Drain

- Ⓢ Standard
- Ⓛ Integrated (option)

#### Installation

- Ⓜ Undermounted
- Ⓣ TOP Sit-on basin, sit on bowl, sit on shower tray
- Ⓛ Floor level (only for shower trays)

#### Tap hole

- Ⓞ With drilled tap/faucet hole
- Ⓞ Without drilled tap/faucet hole

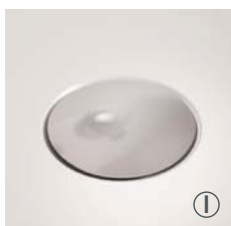
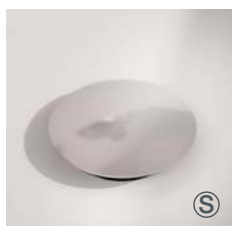

For basins with central drains, you can choose different drain options Standard (S) or Integrated (Option)

All dimensions in mm. Colour variation and change of dimension may vary due to the installation method.



Personalise your design. The wide range of solid surface aesthetics offer an inspiring selection of solid, textured and translucent tones. You can accentuate your design with inlays or by contrasting your bowl and surface colours. It is also possible to combine your basin with other materials like metal, wood, stone or glass.

Image: VR 30 Integrated washbasin

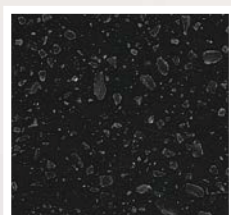
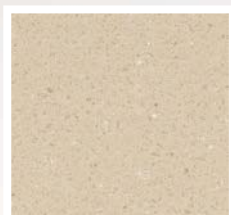
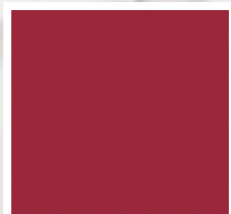
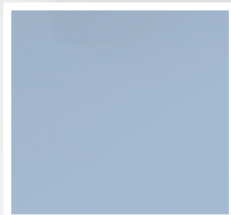

An extract from our colour range – Choose from a large number of colours and textures.\*

\* Some dark colours and textures may vary in intensity and highlight joints. Please take note of our price group overview.

# Washbasins & Washstands

Individual bathroom design by PFEIFFER – Your oasis of relaxation. The pleasure of purity and elegance. Choose your preferred style and enjoy it.

With our range of products we have the right concept for your bathroom. Choose between built-in washbasins, which can be seamlessly integrated into a solid surface vanity top or combine a sit-on bowl with other exclusive materials and a PFEIFFER cabinet for your personal items.

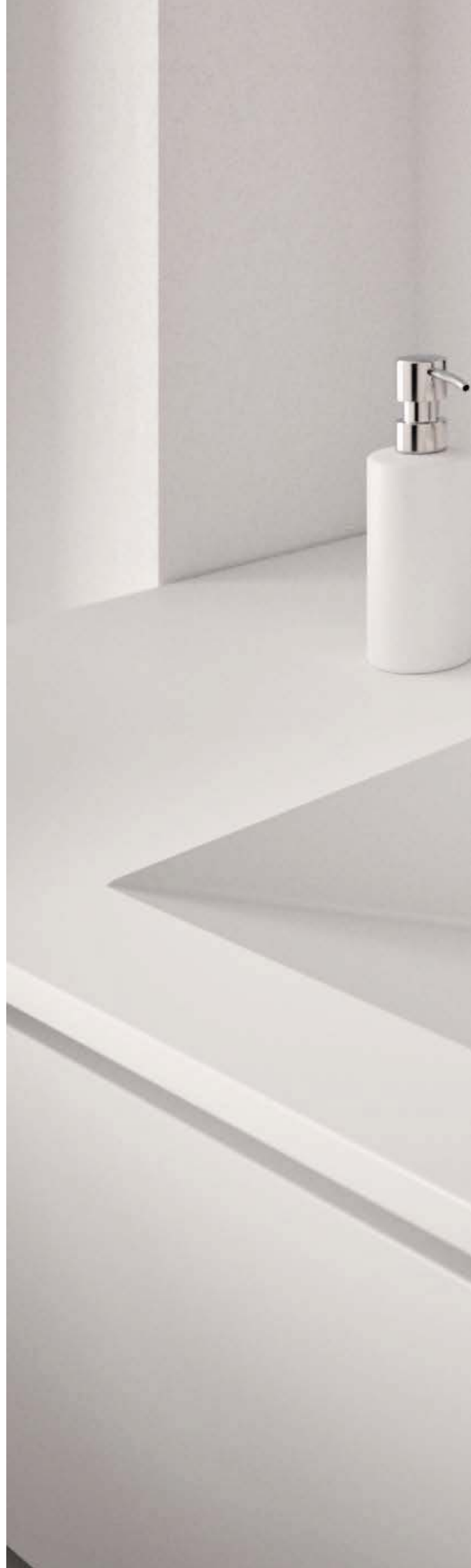





# VR-Series

## Washbasins – Round

The VR-Series basins adapt to every installation. The drain cover is available in two formats – Standard (S) and Integrated (I).

**VR 24**



Depth: 116 mm



**VR 30**



Depth: 130 mm



**VR 37**



Depth: 150 mm



**VR 40**



Depth: 130 mm



**VR 45**



Depth: 150 mm



**VR 50 FS**



Depth: 41 mm





# VO-Series

## Washbasins – Oval

VIVARI® VO-Series – attractive designs for your bathroom. Whether as a single or double vanity, VIVARI® basins give your bathroom a personal touch.

**VO 37**

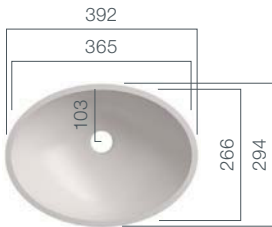

Depth: 120 mm



**VO 42**

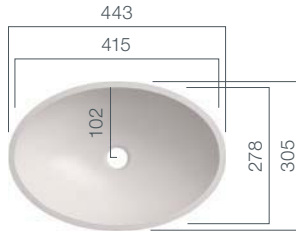

Depth: 111 mm



**VO 48**

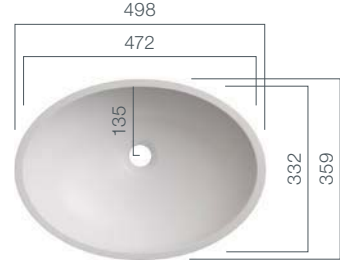

Depth: 124 mm



**VO 53**

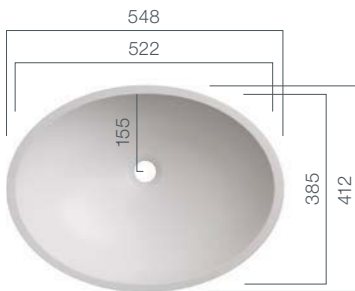

Depth: 142 mm



**VO 57**

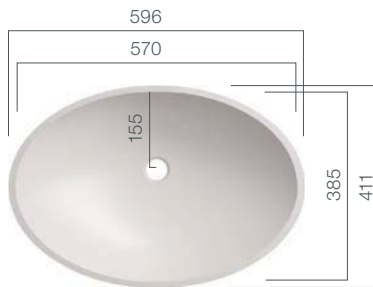

Depth: 135 mm



One basin, different options. VR and VO – Also available as counter-top bowl.





# ● VB-Series

## Baby Baths

The VB-Series is a special series for the paediatric ward. The warm feel and its antibacterial property offers the ideal atmosphere for the daily care.

**VB 67**



Depth: 143 mm



**VB 68**

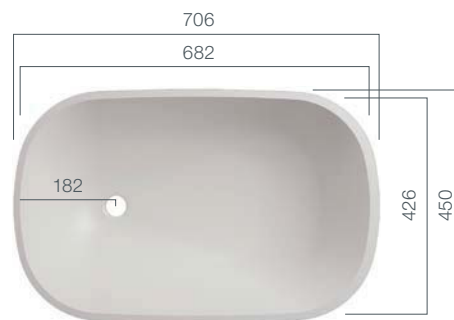

Depth: 172 mm



**VB 800**



Depth: 70 mm



**VB 85**



Depth: 250 mm





# VDA-Series

## Washbasins

As an integral part of the wash area, VIVARI® basins are the hygienic partner in your daily life. Our seamlessly integrated bowls make cleaning easy.

**VDA 47**

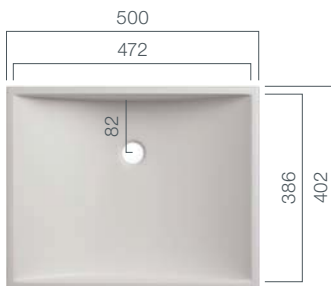

Depth: 122 mm



**VDA 58**

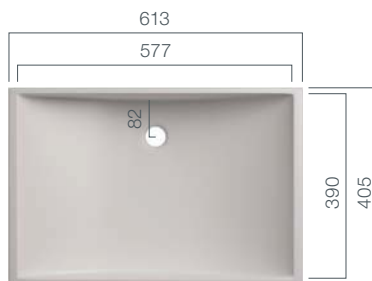

Depth: 122 mm



**VDA 58.370**

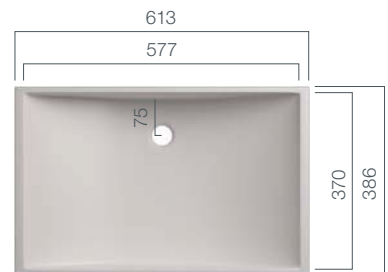

Depth: 122 mm



**VDA 58.200**

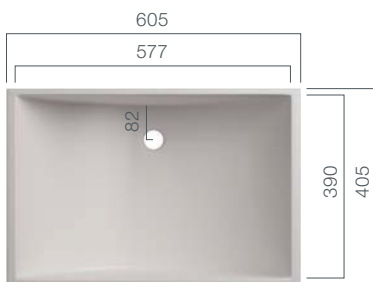

Depth: 200 mm



**VDA 1100**

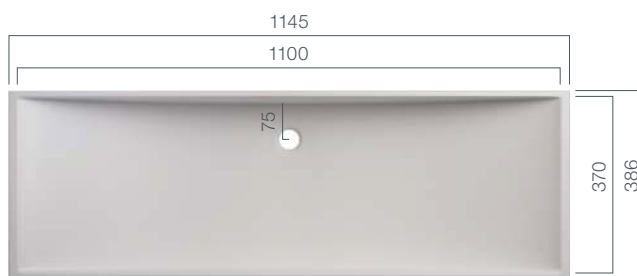

Depth: 115 mm



# VDC-Series

## Washbasins

With clear geometries and deliberate emphasis on the basin shapes, the VDC Series enable you to create your individual bathroom style.

**VDC 400.260**

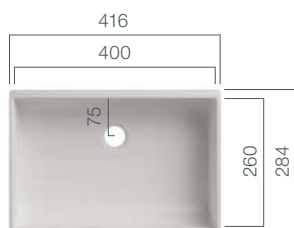

Depth: 100 mm



**VDC 450.300**

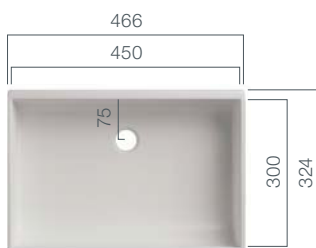

Depth: 125 mm



**VDC 450**

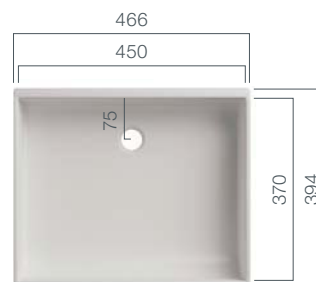

Depth: 125 mm



**VDC 500.300**

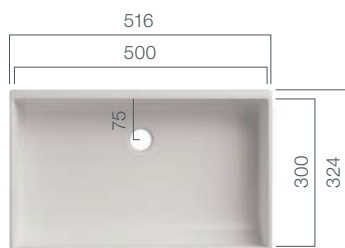

Depth: 125 mm



**VDC 550.300**

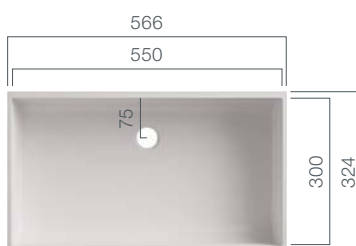

Depth: 125 mm



**VDC 500**

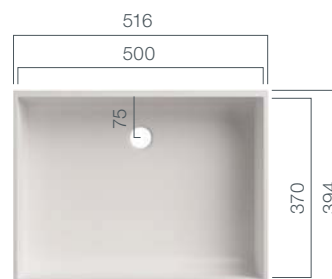

Depth: 125 mm







**VDC 510.280**

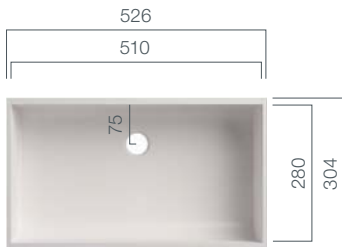

Depth: 125 mm



**VDC 600**

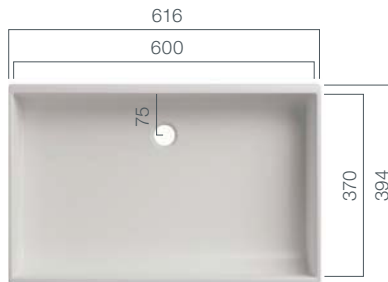

Depth: 125 mm



**VDC 600.300**

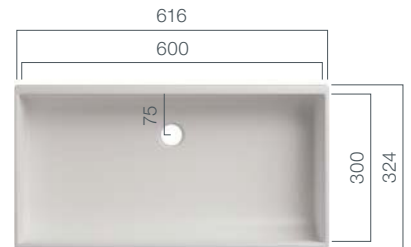

Depth: 125 mm



**VDC 1100\_1**

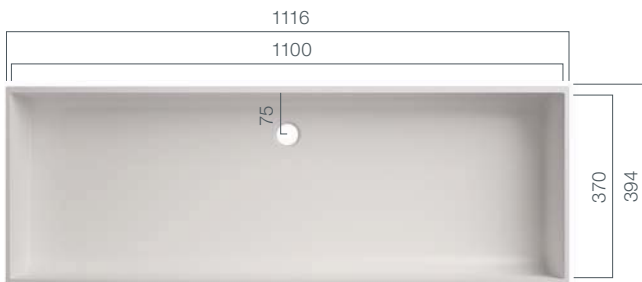

Depth: 125 mm



**VDC 1100\_2**

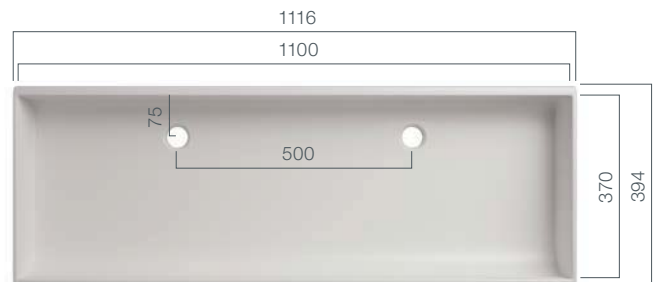

Depth: 125 mm



# VDH/VDS-Series

## Washbasins

Opt for an individual statement in your bathroom with the unusual shapes of the VDH-/VDS series and our broad range of solid surface finishes.

**VDH 49**

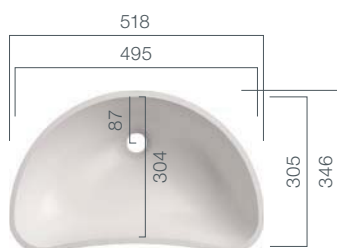

Depth: 120 mm



**VDH 58**



Depth: 151 mm



**VDS 37**

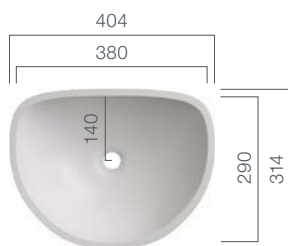

Depth: 140 mm



**VDS 49**



Depth: 155 mm



**VDS 238**



Depth: 145 mm





**VDS 417**



Depth: 137 mm



**VDS 445**



Depth: 137 mm



**VDS 450**

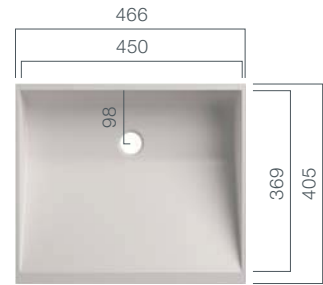

Depth: 105 mm



**VDS 600**

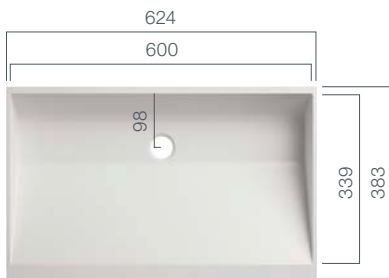

Depth: 103 mm



**VDS 800**



Depth: 90 mm



# VDS R40

## Washbasins

Solid surface materials offer all-round flexibility for seamlessly surfaces and customising your bathroom. The new VDS series R40 and R80 offer both elegance and functionality.

**VDS 470.300.R40**



Depth: 110 mm



**VDS 470.370.R40**

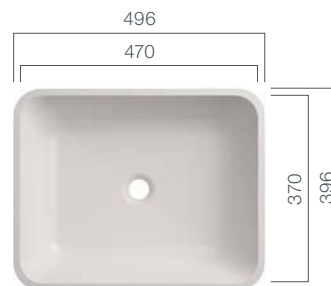

Depth: 110 mm



**VDS 570.300.R40**



Depth: 110 mm



**VDS 570.370.R40**



Depth: 110 mm





**VDS 800.300.R40**

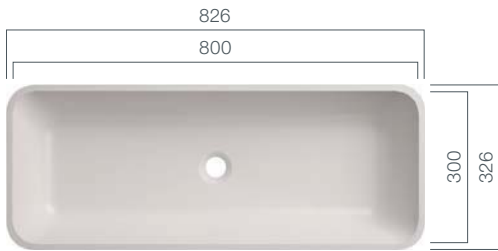

Depth: 110 mm



**VDS 800.370.R40**

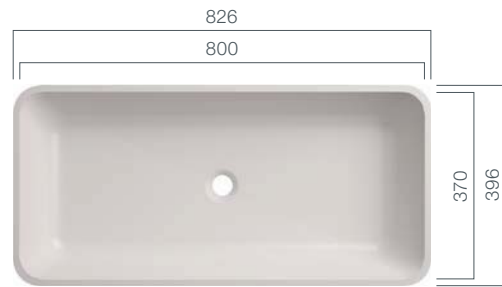

Depth: 110 mm





# ● VDS R40

## Sit-on Basins

Originality and contemporary design. Sit-on basins have become an integral part in modern bathroom design. Experience the urban lifestyle with VDS R40 and R80.

### VDS 450.350.R40 TOP

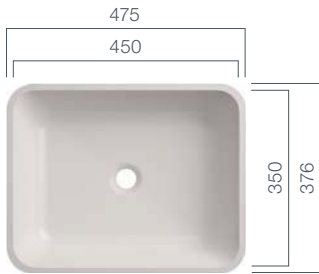

Depth: 90 mm; Total height: 110 mm



### VDS 550.350.R40 TOP



Depth: 90 mm; Total height: 110 mm



### VDS 780.350.R40 TOP

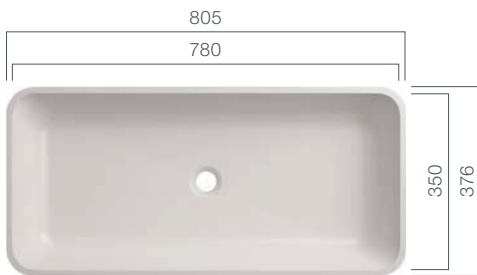

Depth: 90 mm; Total height: 110 mm





# VDS R80

## Washbasins

The new series VDS R40 and VDS R80 offer a variety of designs to personalise your bathroom – whether as a single vanity, sit-on washbasin or free mounted.

**VDS 470.300.R80**



Depth: 110 mm



**VDS 470.370.R80**



Depth: 110 mm



**VDS 570.300.R80**



Depth: 110 mm



**VDS 570.370.R80**



Depth: 110 mm





**VDS 800.300.R80**



Depth: 110 mm



**VDS 800.370.R80**



Depth: 110 mm







# VDS R80

## Sit-on Basins

VDS R80 surface-mounted washbasins perfectly harmonise with the PFEIFFER P32 furniture series. The customised cabinets offer sufficient storage with clean and tidy surfaces.

**VDS 460.360.R80 TOP**

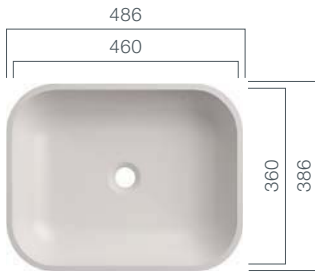

Depth: 90 mm; Total height: 110 mm



**VDS 560.360.R80 TOP**



Depth: 90 mm; Total height: 110 mm



**VDS 790.360.R80 TOP**



Depth: 90 mm; Total height: 110 mm





# VDA-Series

## Sit-on Basins

By combining a VIVARI® TOP basin with a vanity top of wood, natural stone, concrete or glass, you get a design-oriented solution for your bathroom.

### VDA 47 TOP

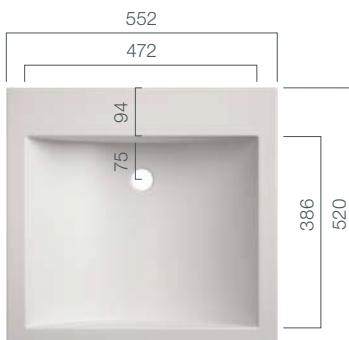

Depth: 128 mm; Total height: 143 mm



### VDA 58 TOP

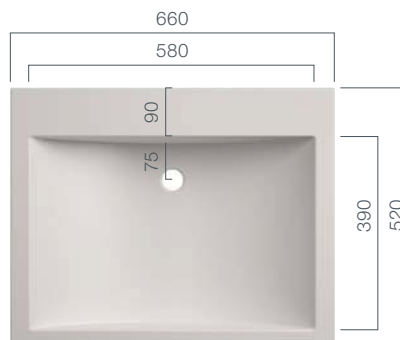

Depth: 128 mm; Total height: 143 mm



### VDA 58.370 TOP

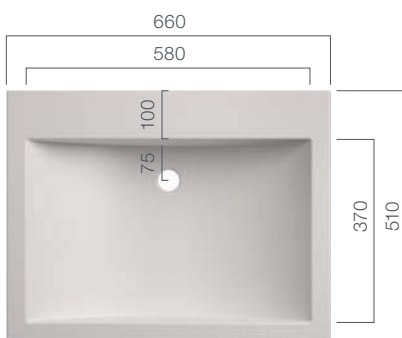

Depth: 128 mm; Total height: 143 mm



### VDA 1100 TOP



Depth: 122 mm; Total height: 143 mm





# VDC-Series

## Sit-on Basins

VIVARI® TOP basins reference the traditional shape of the washbasin. The crisp detailing of the basin shape transforms them into a contemporary design.

**VDC 400.260 TOP**

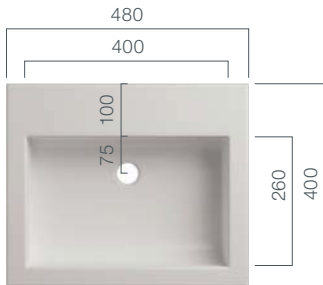

Depth: 106 mm; Total height: 125 mm



**VDC 450.300 TOP**

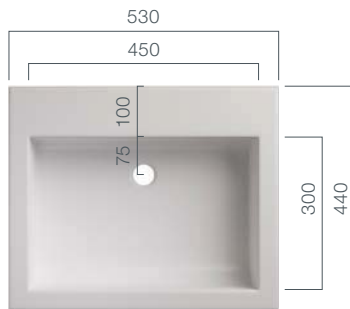

Depth: 132 mm; Total height: 148 mm



**VDC 450 TOP**

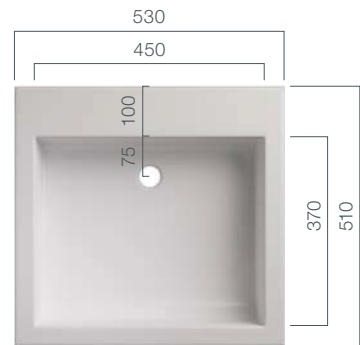

Depth: 132 mm; Total height: 148 mm



**VDC 500.300 TOP**

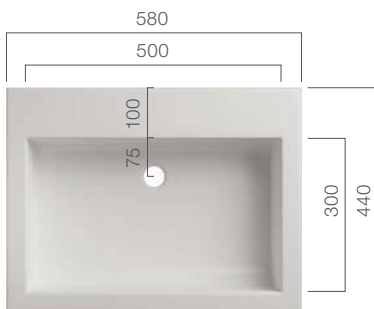

Depth: 132 mm; Total height: 148 mm



**VDC 550.300 TOP**

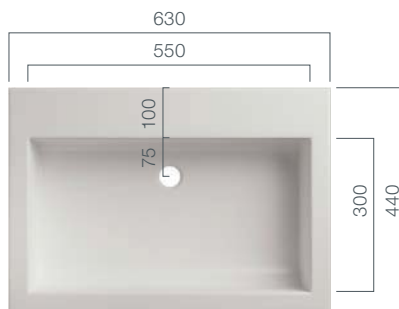

Depth: 132 mm; Total height: 148 mm



**VDC 600 TOP**

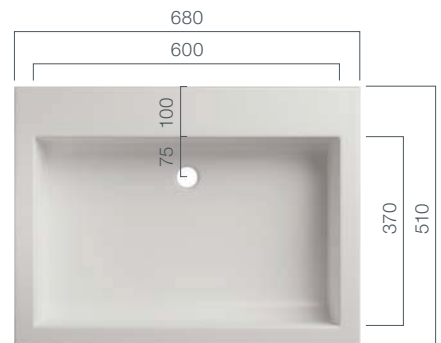

Depth: 132 mm; Total height: 148 mm





**VDC 600.300 TOP**

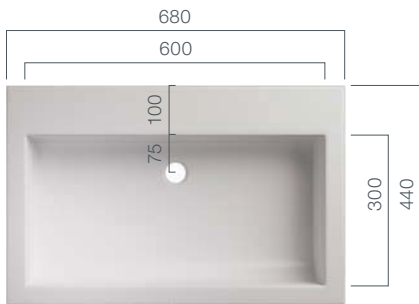

Depth: 132 mm; Total height: 148 mm



**VDC 1100 TOP**



Depth: 132 mm; Total height: 148 mm



**VDC 1100\_2 TOP**



Depth: 132 mm; Total height: 148 mm





# ● VDR-Series

## Sit-on Basins

The circle is a shape with maximum symmetry. Combine solid surface with other natural materials to create unique designs for your bathroom.

**VDR 30 TOP**

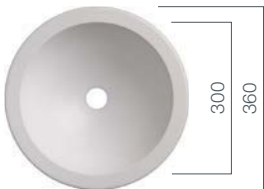

Depth: 150 mm



**VDR 37 TOP**



Depth: 170 mm



**VDR 40 TOP**



Depth: 170 mm



**VDR 45 TOP**



Depth: 170 mm





# ● VDRO-Series

## Semi-Recessed Basins

A semi-recessed basin is the option for washing areas with limited space. The precisely defined edge enables a clean integration to all counter-top materials.

**VDRO 30**



Total height: 140 mm



**VDRO 37**



Total height: 160 mm



**VDRO 40**



Total height: 160 mm



**VDRO 45**



Total height: 160 mm



Please indicate the exact vanity top thickness for an accurate fit of the washbasin.

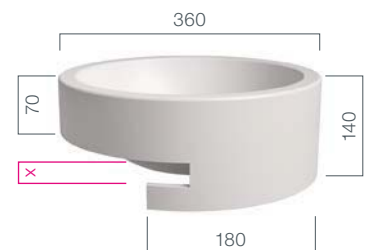

Exemplary image: VDRO 30



# ● VDS/WT-Series

## Vanity Tops

Finished washstands of VDS/WT-Series have variable lengths. VIVARI® – made to measure.

### VDS 37/WT

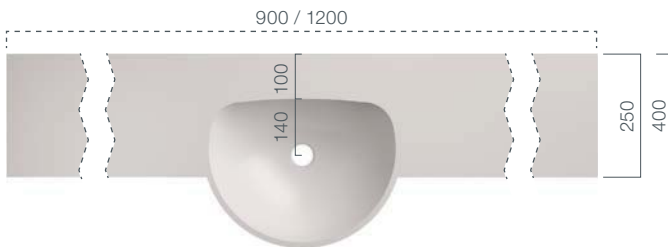

Depth: 140 mm; Vanity top thickness: 40 mm; Edges: three sides covered

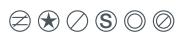

### VDS 49/WT

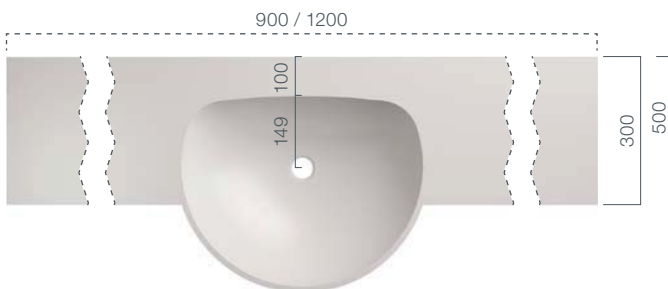

Depth: 151 mm; Vanity top thickness: 40 mm; Edges: three sides covered





# SINGLE

## Furniture Vanity Tops

The new OPUS series are furniture vanity tops with flexible lengths. The vanity consists of a single sheet of solid surface material and is ideally suited for high use private and public spaces.

**OPUS 620 | OPUS 720 | OPUS 820 | OPUS 920 | OPUS 1020 |  
OPUS 1120 | OPUS 1220 | OPUS 1320 | OPUS 1420 | OPUS 1520**

620 / 720 / 820 / 920 / 1020 / 1120 / 1220 / 1320 / 1420 / 1520

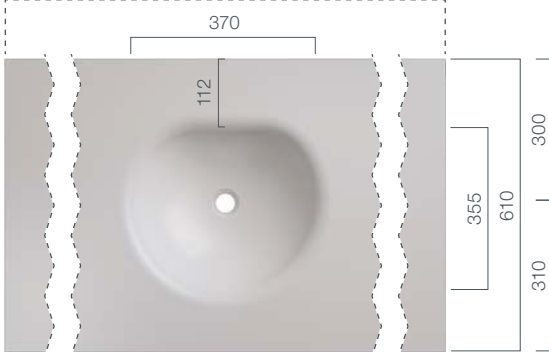

Bowl central; Depth: 130 mm



620 / 720 / 820 / 920 / 1020 / 1120 / 1220 / 1320 / 1420 / 1520

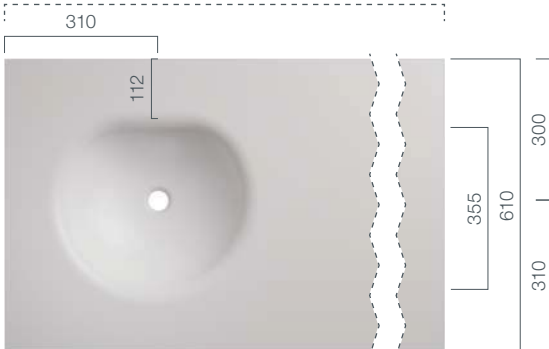

Bowl left; Depth: 130 mm



620 / 720 / 820 / 920 / 1020 / 1120 / 1220 / 1320 / 1420 / 1520

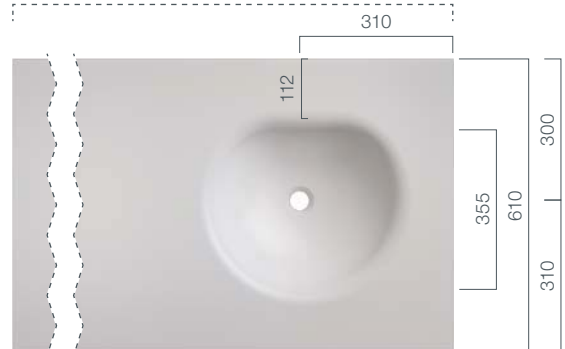

Bowl right; Depth: 130 mm







# ● DOUBLE

## Furniture Vanity Tops

The cabinets for our OPUS series are customised to the dimensions of the vanity. Together they build a harmonious unit.

### OPUS 1220\_2

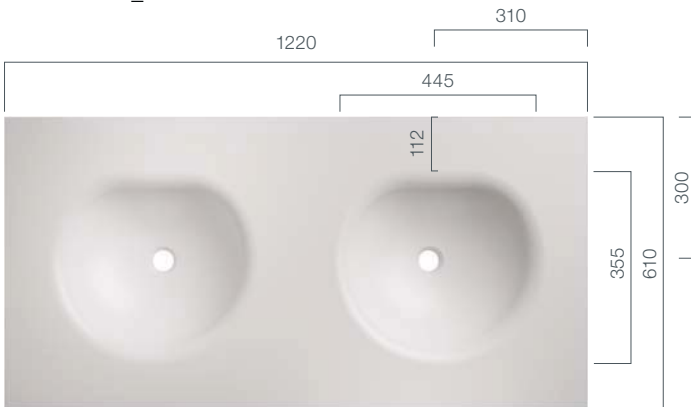

Depth: 130 mm



### OPUS 1520\_2

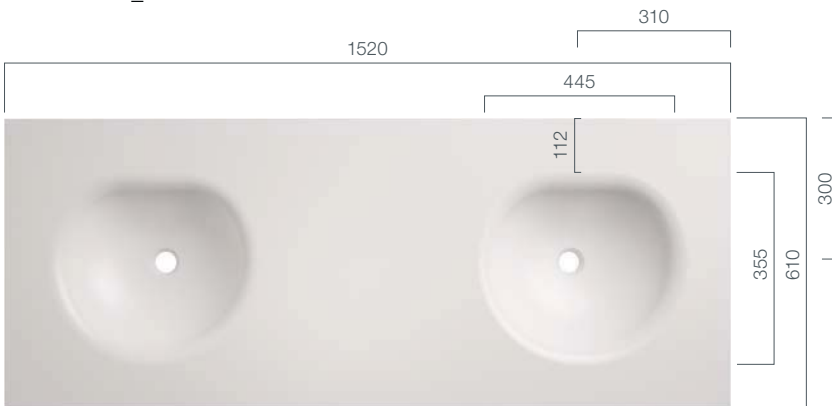

Depth: 130 mm





**● OLIVE**  
Furniture Vanity Tops

In rational terms, products must have a long life, be easy to maintain and practical; in emotional terms, they must satisfy the aspiration for exclusivity.

**OLIVE 900 | OLIVE 1200 | OLIVE 1500**

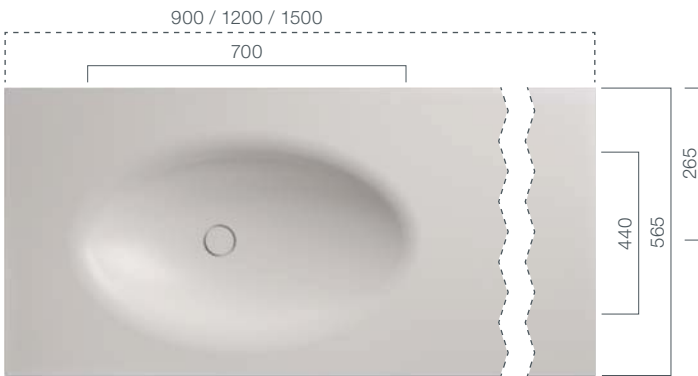

Depth: 135 mm





# BRAVO

## Furniture Vanity Tops

The new BRAVO series are furniture vanity tops of varied lengths. The vanity consists of one single sheet of solid surface material and is ideally suited for high use private and public spaces.

**BRAVO 620 | BRAVO 720 | BRAVO 820 | BRAVO 920 | BRAVO 1020 |  
BRAVO 1120 | BRAVO 1220 | BRAVO 1320 | BRAVO 1420 | BRAVO 1520**

620 / 720 / 820 / 920 / 1020 / 1120 / 1220 / 1320 / 1420 / 1520

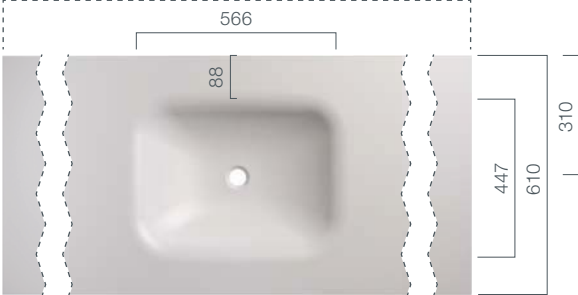

Bowl central; Depth: 120 mm



620 / 720 / 820 / 920 / 1020 / 1120 / 1220 / 1320 / 1420 / 1520

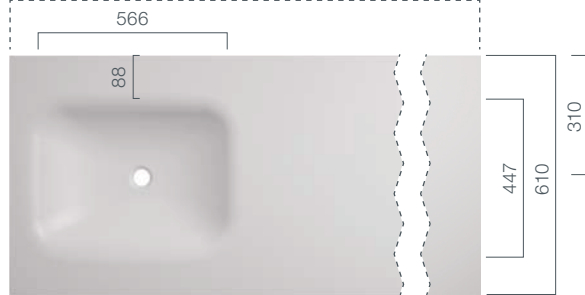

Bowl left; Depth: 120 mm



Bowl right; Depth: 120 mm



1220 / 1520

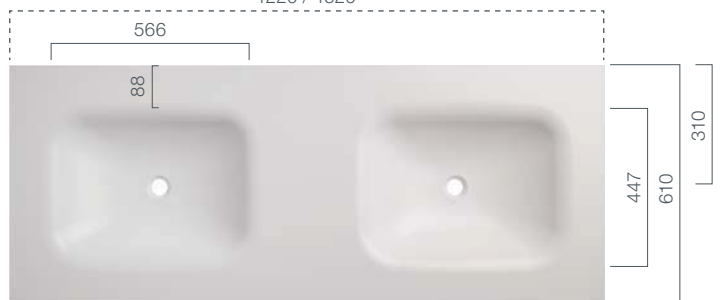

Depth: 120 mm





**PURE**  
Washstands

The combination of strong geometric lines with soft and round shapes produces a harmonic image.  
(Design PURE 10/20/30: NOA Intelligent Design, Aachen)

**PURE 10**



Depth: 170 mm; Total height: 155 mm;  
Ø Tap plinth: 50 mm

**PURE 20**

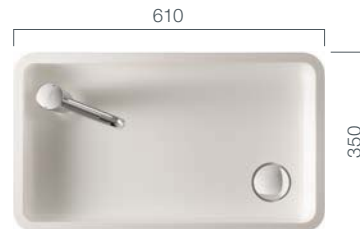

Depth: 60 mm; Total height: 120 mm;  
Ø Tap plinth: 50 mm

**PURE 30**



Total height: 340 mm

**PURE 900**



Depth: 220 mm



# PURE SLOT

Linear Drain Vanity

Outstanding design for purists. Your place for personality. Combine PURE Slot with Pfeiffer P32 cabinets.

## PURE SLOT 500

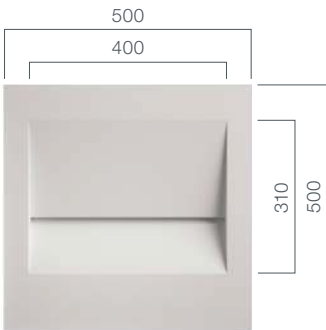

Depth: 80 mm

## PURE SLOT 600

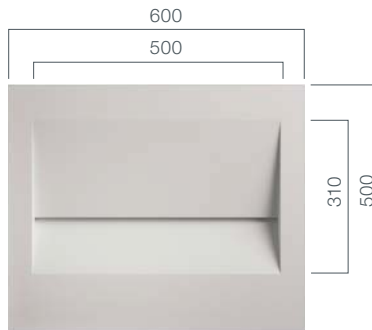

Depth: 80 mm

## PURE SLOT 700



Depth: 80 mm

## PURE SLOT 800



Depth: 80 mm

# Shower trays made to measure

In the beginning, there was the goal: to create an ambience as multifaceted as the spirit of our times.

The result: a product line for the bathroom that you can freely design according to your own desires and imagination. Dimensions are blown open and freedom made visible. With AQUAMASTER range, creativity knows no limits.

Experience maximum freedom of movement with our XXL shower trays. Where other materials reach their limit, we can produce your customized solution. Seamless integrated components like benches or storage space complete our solution. This opens the way for unlimited shower delight.

The 12 mm thick solid surface material provides a uniform surface and is certified according to the international standard DIN ISO 846. Neither bacteria nor mildew can take root. Aesthetics and functionality complement one another seamlessly with AQUAMASTER.





# AQUAMASTER XERO

## Flexibility in any format

XERO gives you the option of implementing a variety of customized system solutions in addition to standard shapes – without having to restrict your planning freedom. Use the numerous options to realise shower trays up to 3000 mm length and 1200 mm width.

### System solutions

- Customization up to 3000 mm length and 1200 mm width
- Variety of colours
- Standard shapes (Square, rectangle, quadrant)
- Easily accessible
- Low installation depth (submounted or flushmounted)
- Easy to clean and maintain
- Circumferential vario joint sealing band (Option)
- Central or offset drain
- Various drain options
- Wall connection as coved backsplash or straight (Option)
- Integrated groove for glass partition wall (Option)
- Anti-slip coating for public areas is possible (Option)
- Drain capacity  $\geq 0,64$  l/s (Depending on the selected drain)

Colour 

Drain  

Installation  



Depending on the installation height of the selected drain.





## Options drain cover

### Standard (VIEGA)

Round  
(Chrome, high-grade brass, golden, solid surface or plastics)



### Integrated (DALLMER)

Square  
(Stainless steel or solid surface)

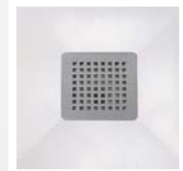

Round  
(Stainless steel or solid surface)



Channel  
(Stainless steel or solid surface)

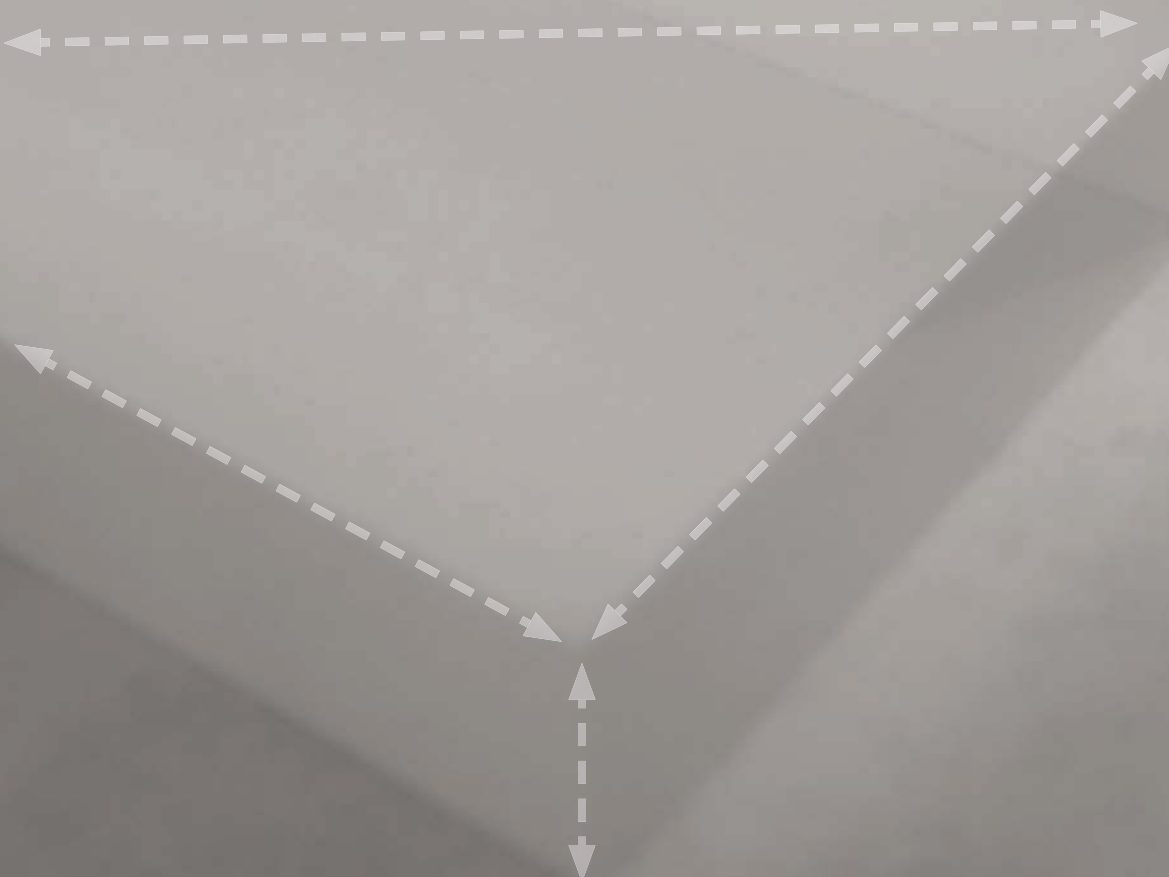
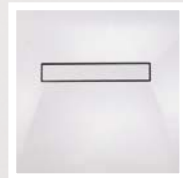



# FLEX50

## Shower Trays

Benefit from the added value for your new building or renovation project. By shortening the revolving 50 mm functional rim in the factory, the shower tray can be easily adapted to up to 100 mm in length and width.

### FLEX50

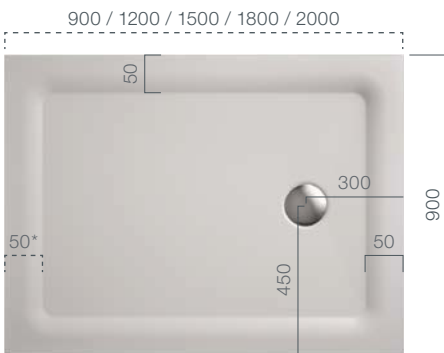

Flushmounted;  
\*functional rim (can be shortened in a flexible way)  
⊗ ⊕ ⊖ ⊙

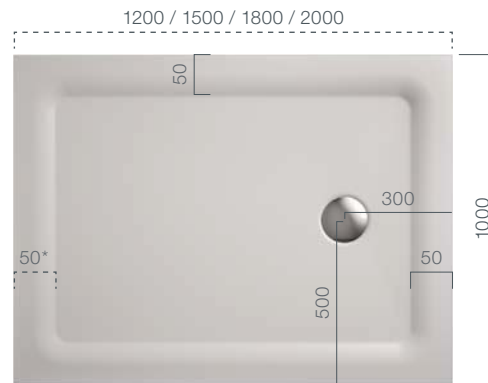

Flushmounted;  
\*functional rim (can be shortened in a flexible way)  
⊗ ⊕ ⊖ ⊙

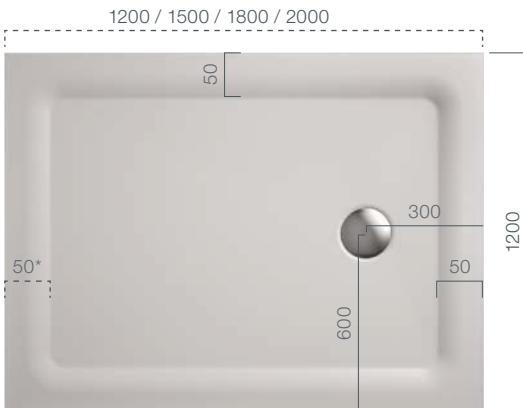

Flushmounted;  
\*functional rim (can be shortened in a flexible way)  
⊗ ⊕ ⊖ ⊙

All shower trays as well as in custom sizes.



Flushmounted;  
\*functional rim (can be shortened in a flexible way)  
⊗ ⊕ ⊖ ⊙

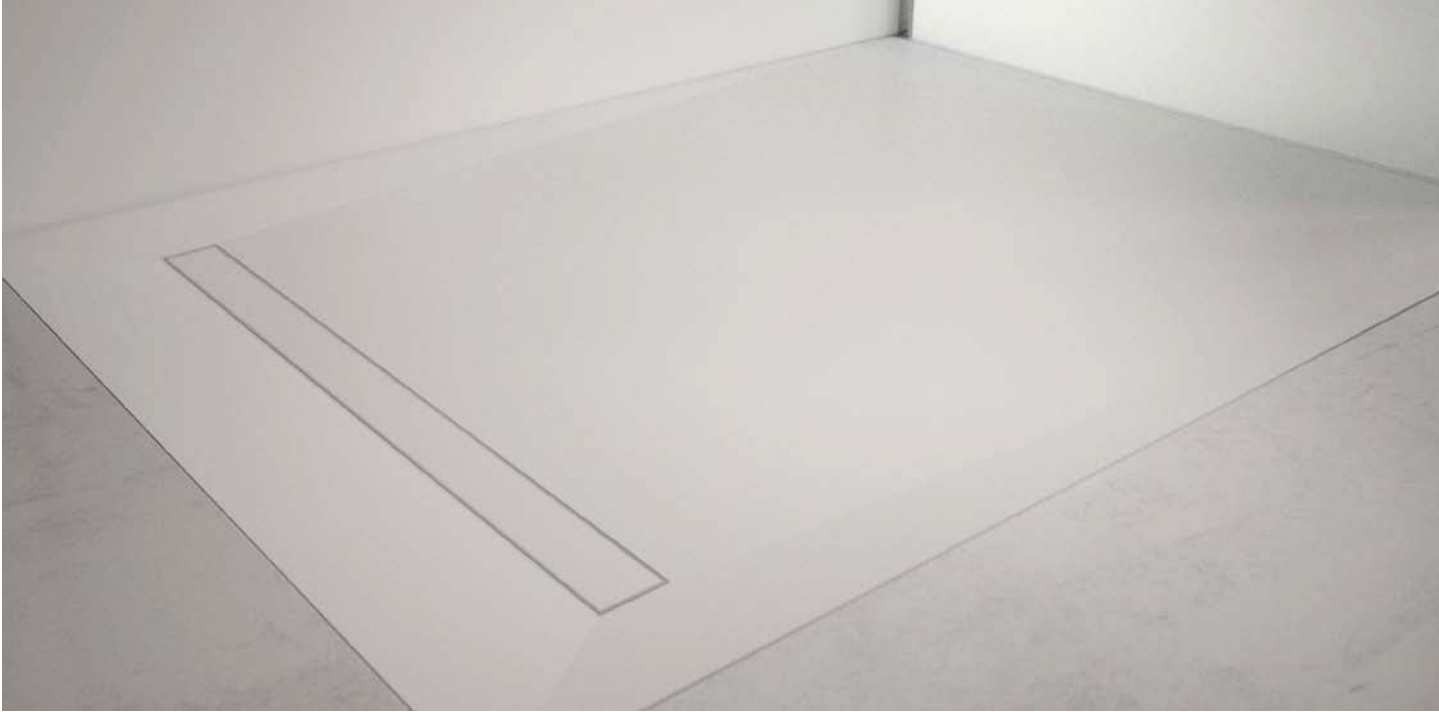

**XERO**  
Shower Trays

Low installation depth – maximum freedom to plan the shower tray. In addition to our standard shapes, we can make your customized solution to millimetre accuracy. Realise a shower tray like no other.

**XERO square – Drain central**

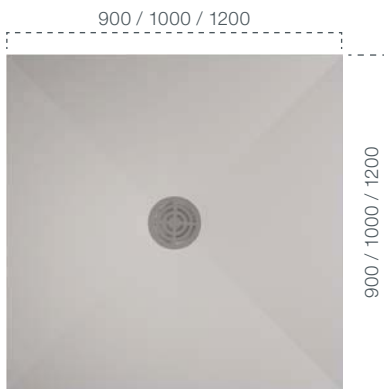

Flushmounted

**XERO square – Drain offset**

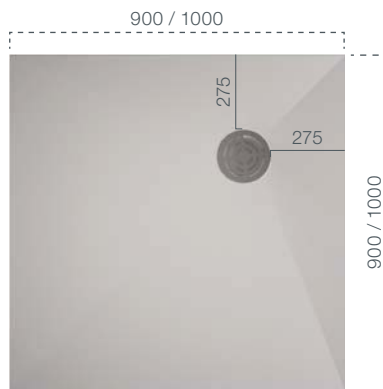

Flushmounted

**XERO rectangle – Drain offset**

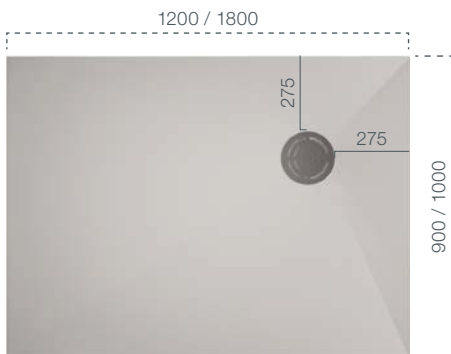

Flushmounted

**Your desired format**

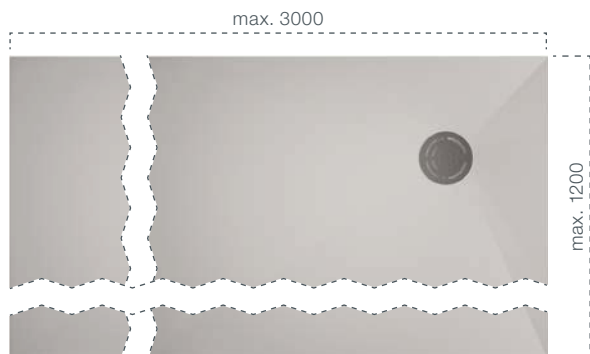

# Baths

Complete your exclusive ambience with a AQUAMASTER bath tub. The velvety feel and look guarantee a feel-good experience.

Our product range consists of two standard shapes ROUND and CUBE. You also have the opportunity to bring your own ideas in the design of your bath tub.

How about a XXL Shower-bath-tub-combination or a wellness tub with steps for entrance and enough storage space for wellness equipment?







● ROUND

Bath

ROUND is the best solution for individualists. Its convincing arguments are a striking image, excellent hygienic properties, central drain and an overflow cover in the same colour.

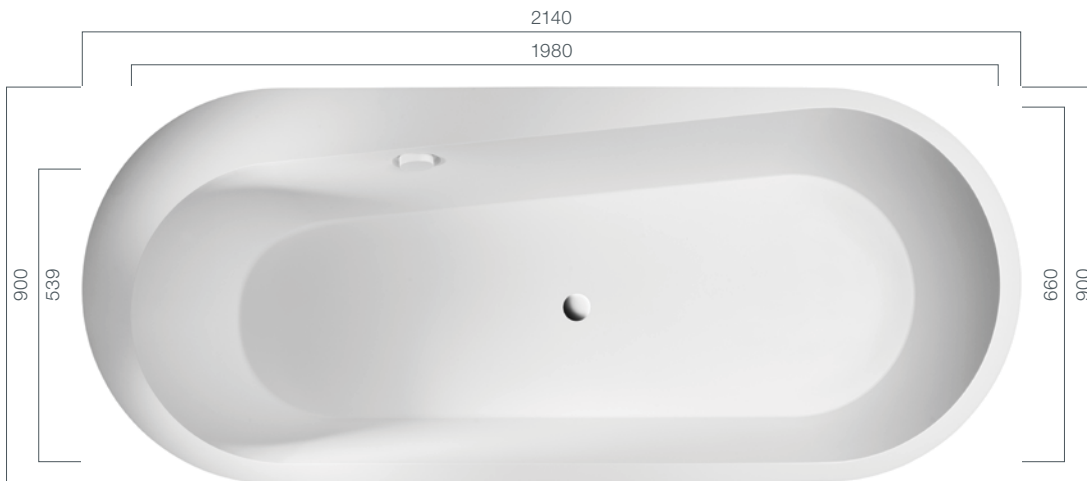

Depth: 473 mm | Total height: 650 mm



● CUBE  
Bath

CUBE is the best solution for minimalists. Its convincing arguments are excellent hygienic properties, central drain and an overflow cover in the same colour.

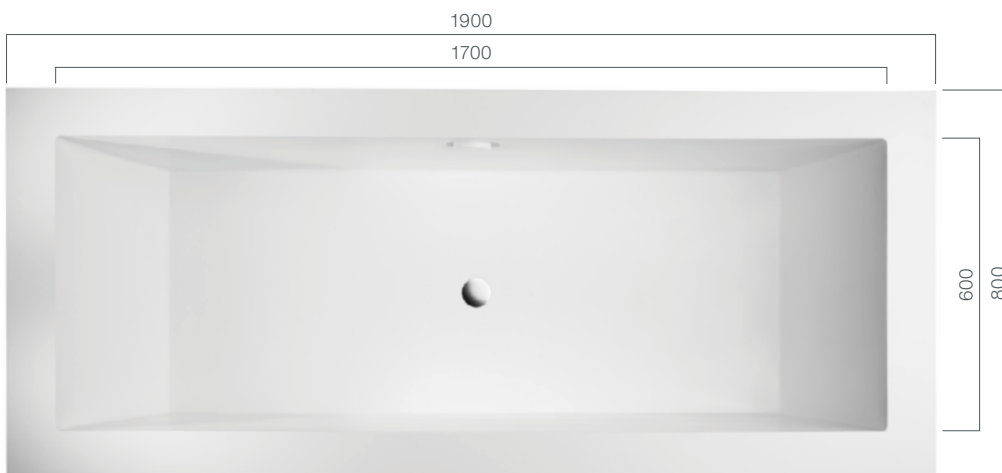

Depth: 480 mm | Total height: 650 mm

pfeiffer.

Pfeiffer GmbH & Co. KG  
Emmeliusstraße 21  
D-35614 Asslar  
Fon +49 (0)6441.9833-0  
Fax +49 (0)6441.9833-30



[www.pfeiffer-germany.de](http://www.pfeiffer-germany.de) • [info@pfeiffer-germany.de](mailto:info@pfeiffer-germany.de)

VIVARI® is a registered trademark. VIVARI® is produced by Pfeiffer GmbH & Co. KG only.  
AQUAMASTER is produced by Pfeiffer GmbH & Co. KG only.